

HORNS PATTERN DIY

FOAM

Apply the pattern to the 5mm eva foam and cut it out

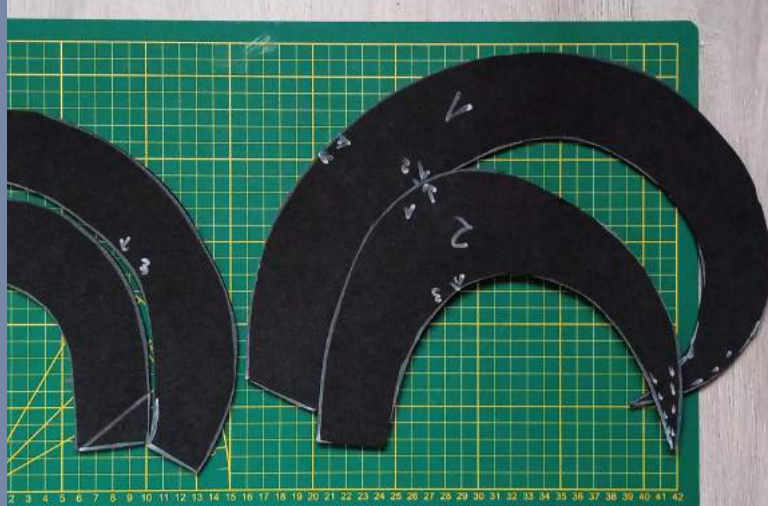

1



2



GLUED

First, apply glue to all the edges. When the glue dries, glue elements 1 and 2 together



NEXT

then glue parts 3 and 4 together

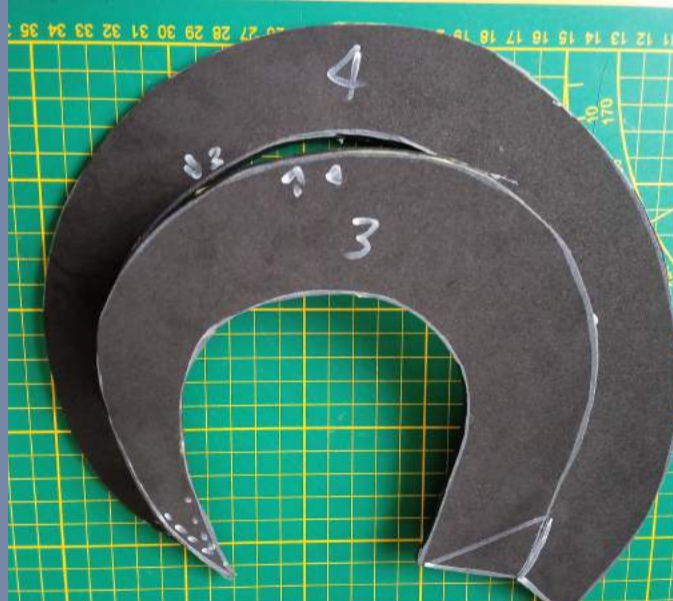

3



NEXT

looks like this after gluing

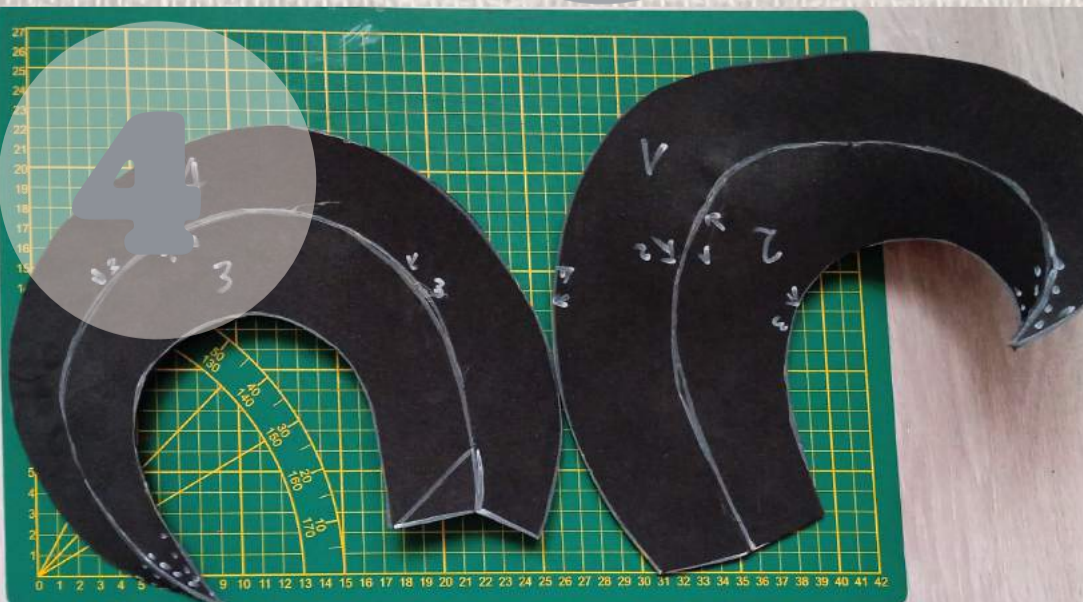

HORNS PATTERN DIY

IMPORTANT

Now glue parts 1 and 4 together

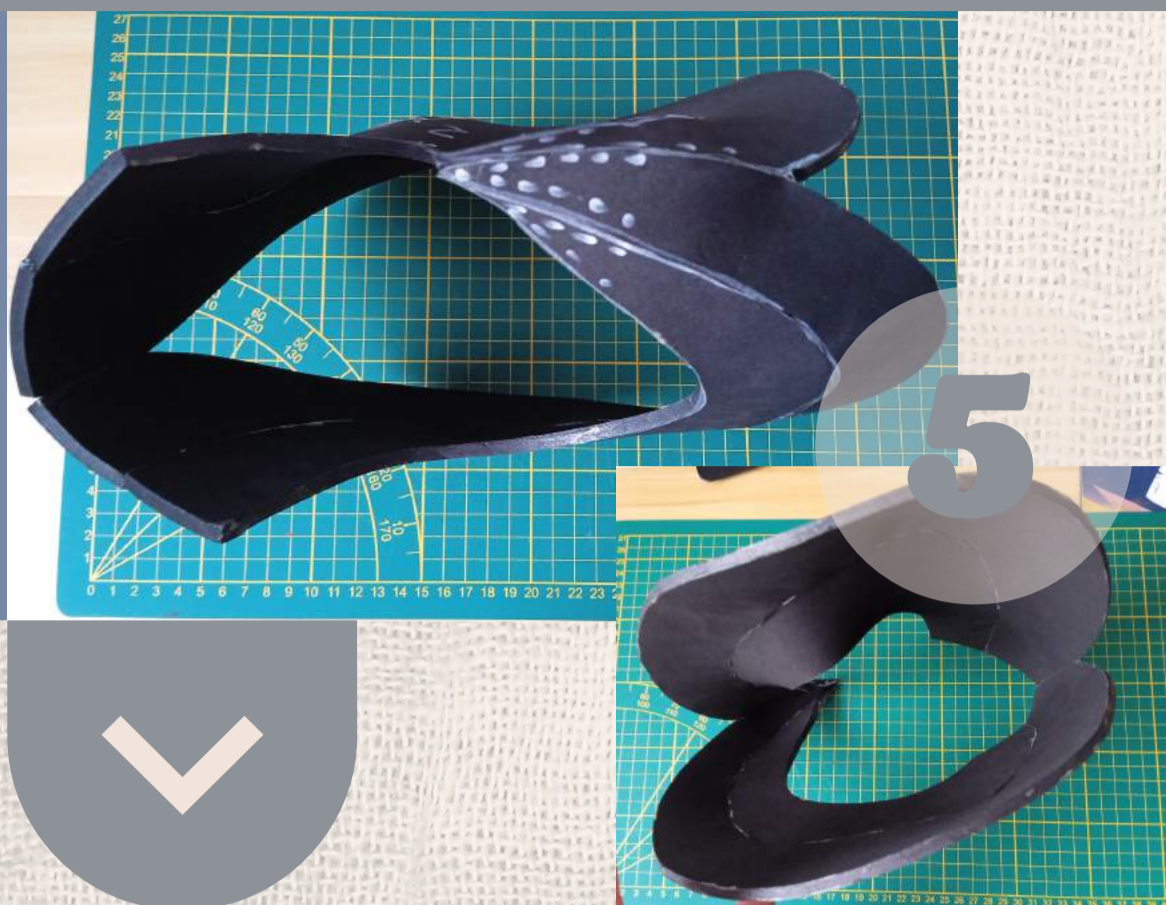

6

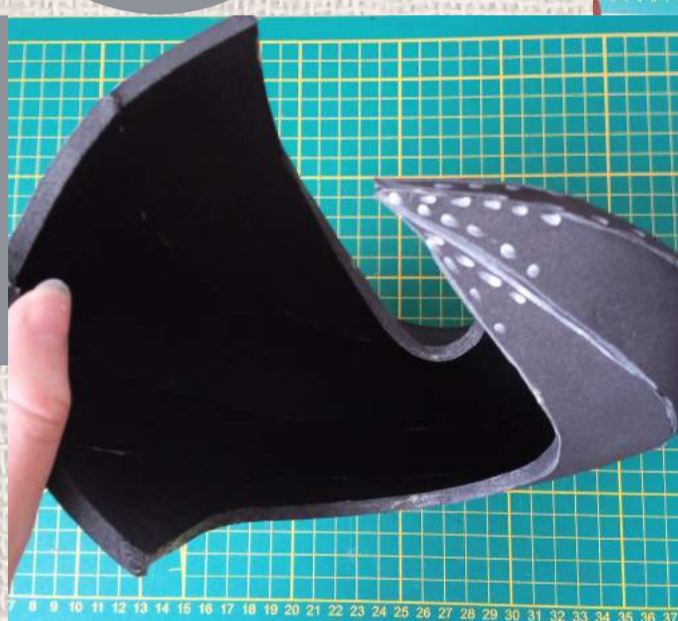

LAST

When you glue these two elements together, it's time for the last part



ALMOST DONE

Start by gluing the spike as shown in the picture, part 2 and 3



7



8

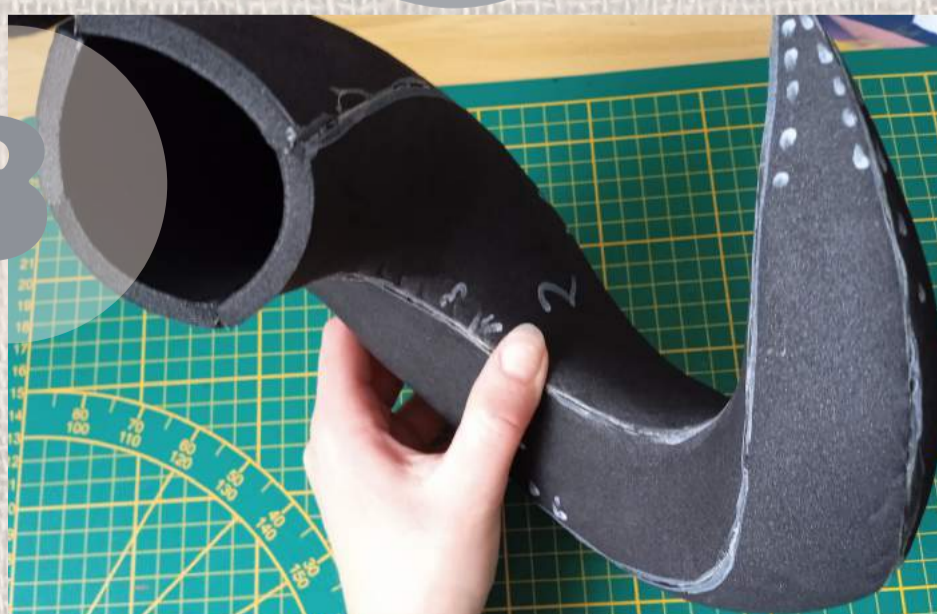

TRUST THE PROCESS

Now the hardest thing. glue parts 2 and 3 together and you're done!

More patterns at:
[etsy.com/LycosaStore](https://www.etsy.com/LycosaStore)



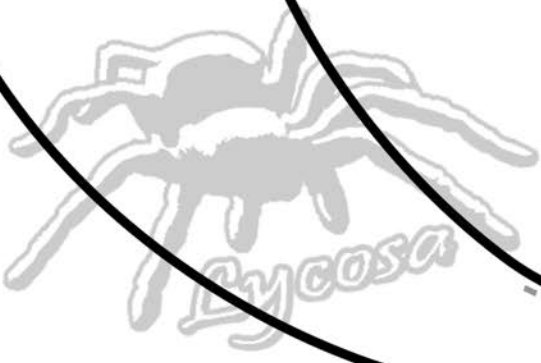
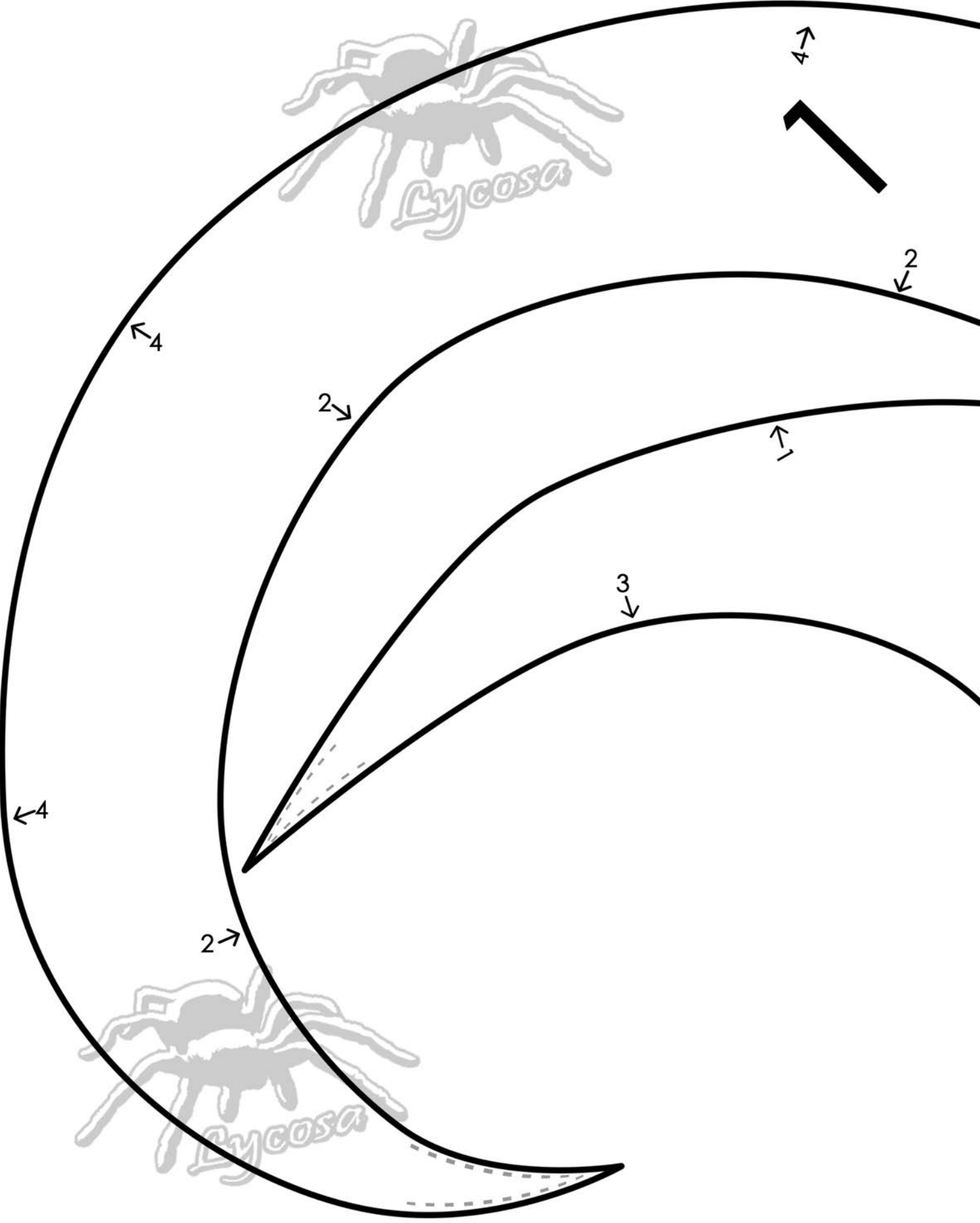
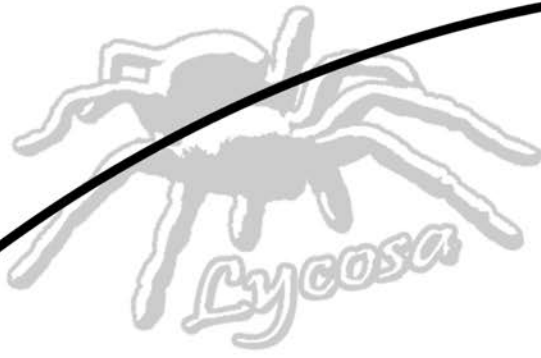

R

4 →

2

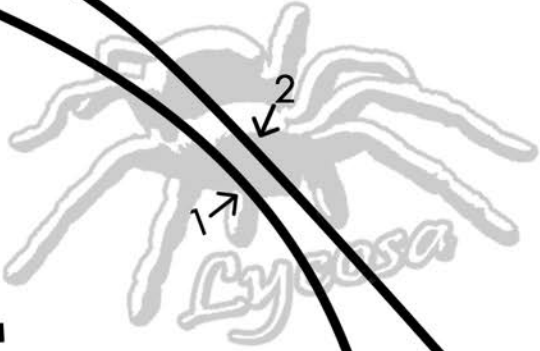

1 →

2 ↓

← 3

R

1 ↓

← 3

2

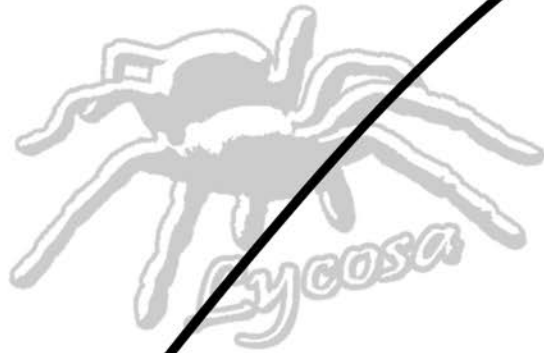

L

←4

2↘

←1

2

3→

L

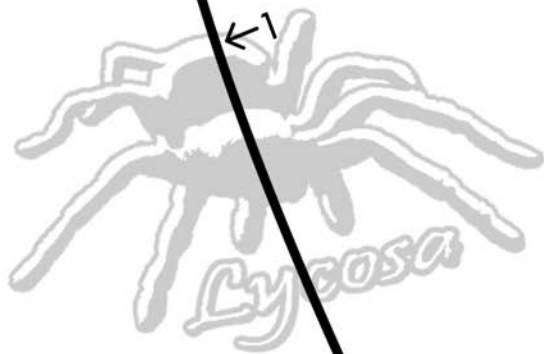

←1

3→

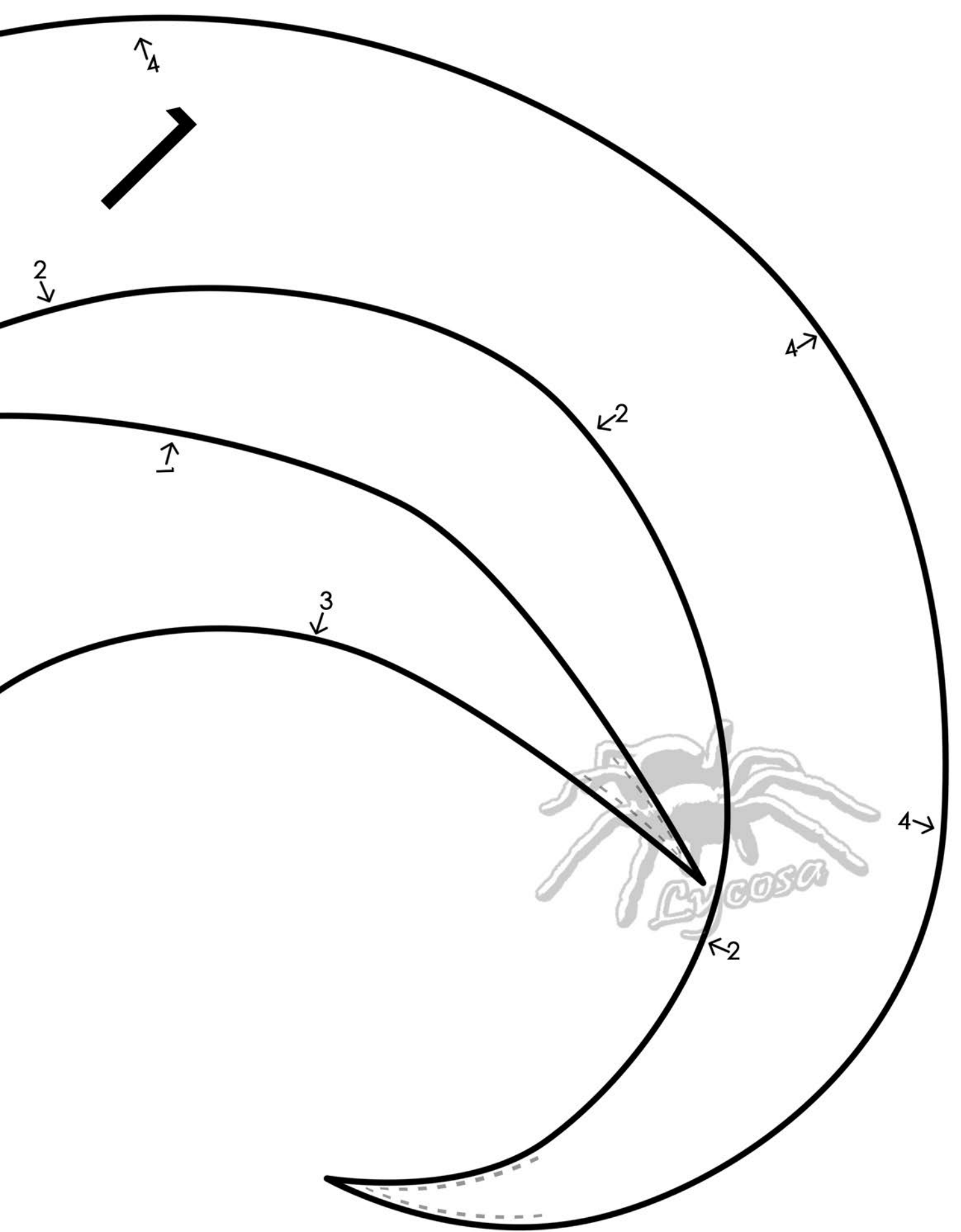

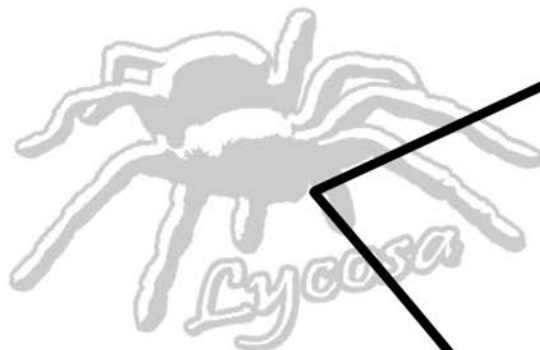

R

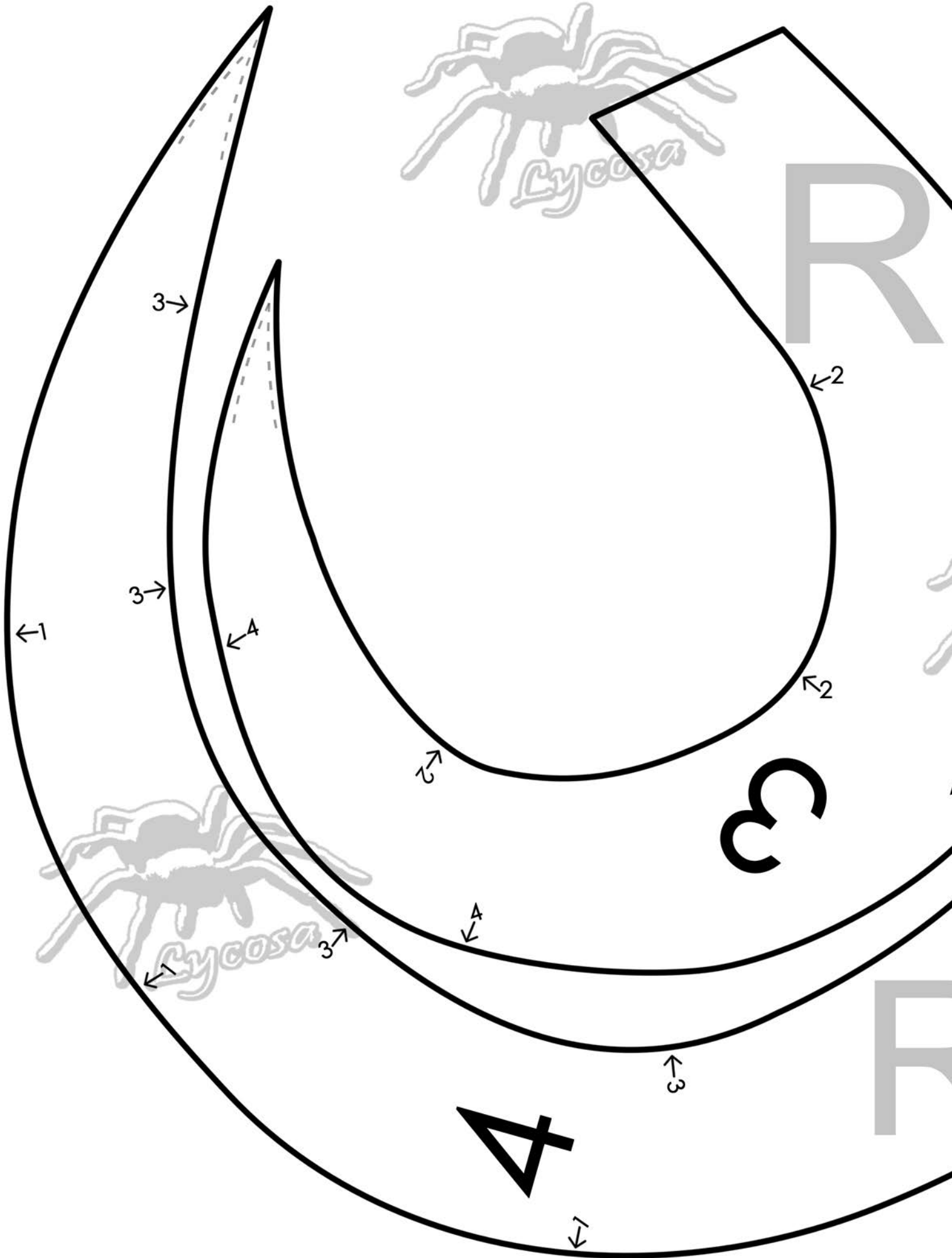

3

R

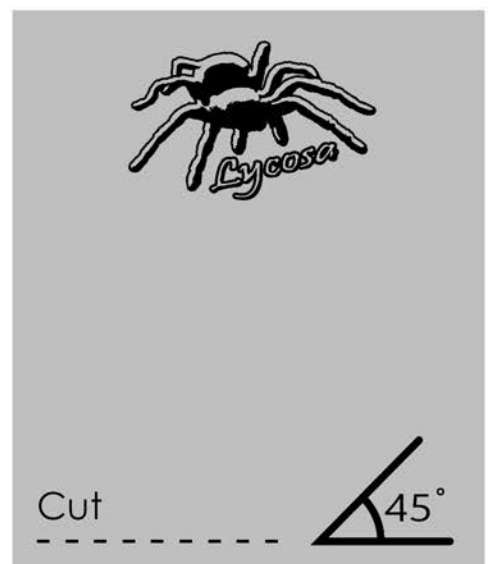
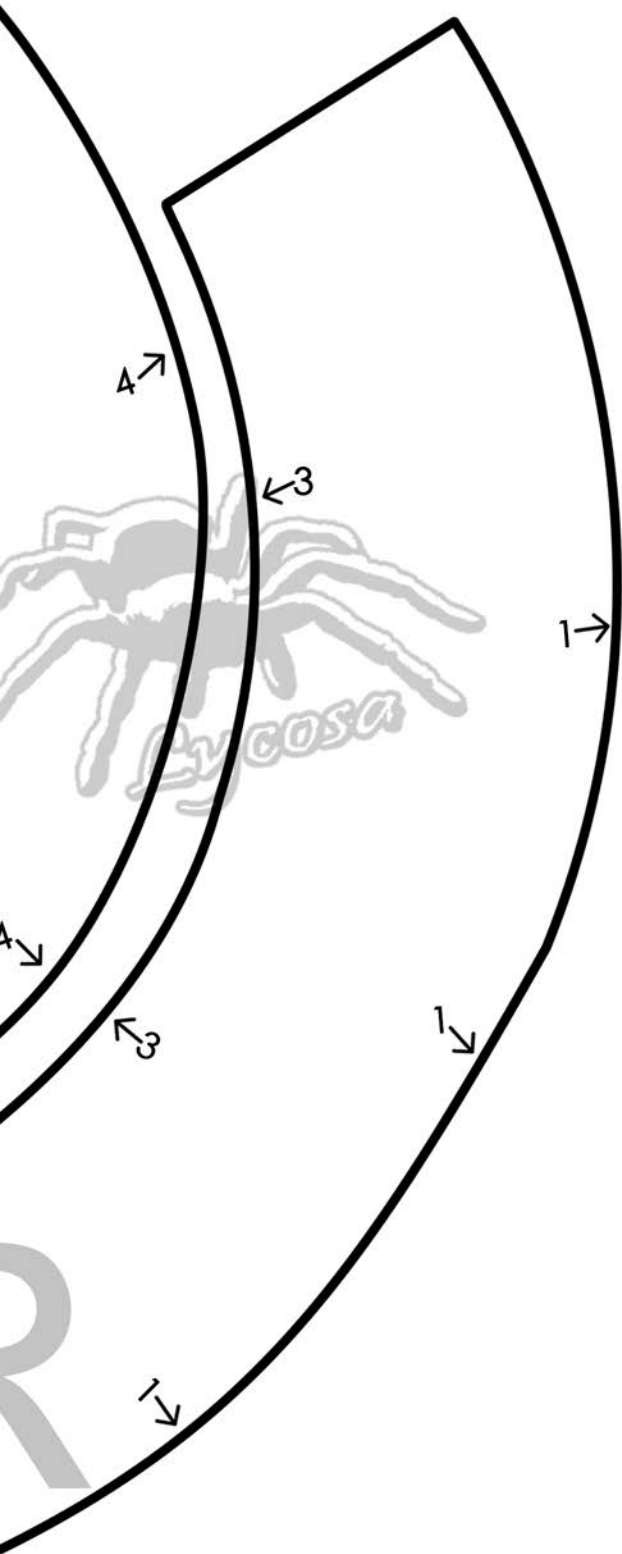

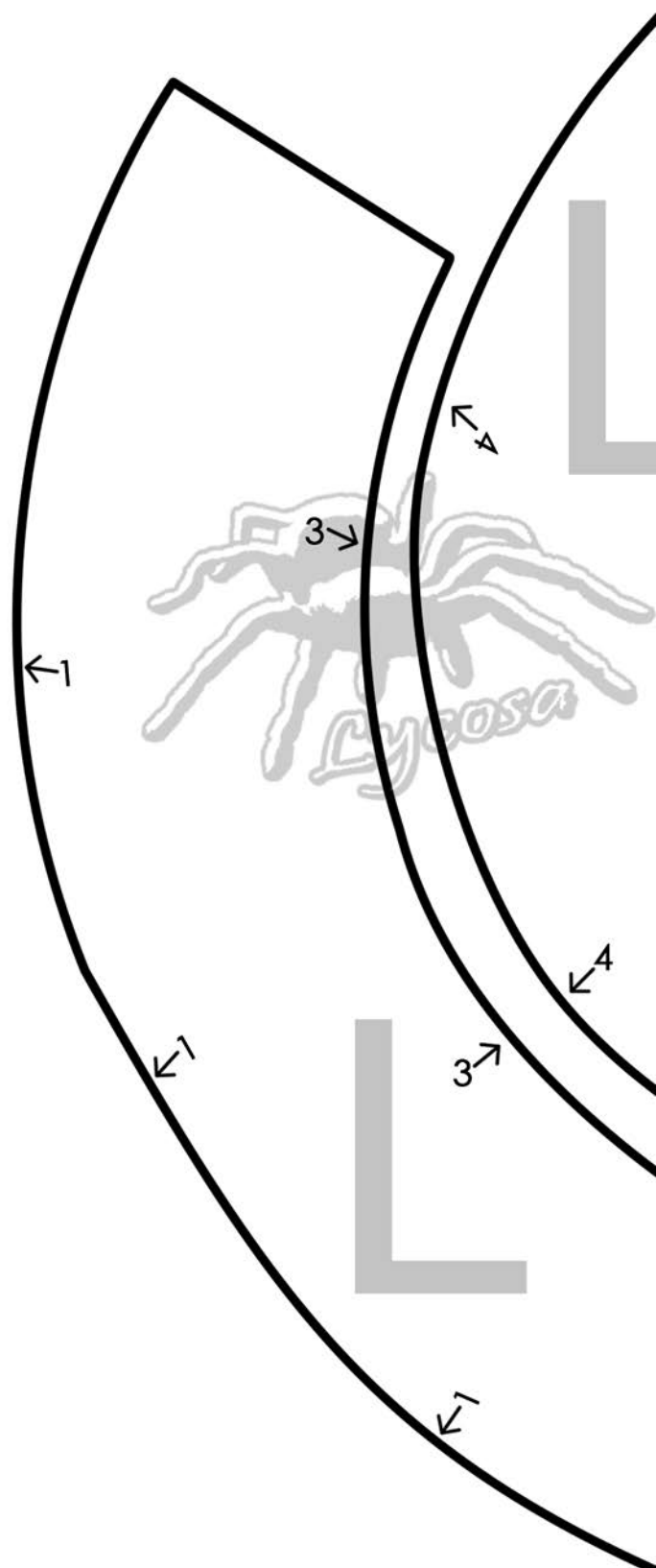

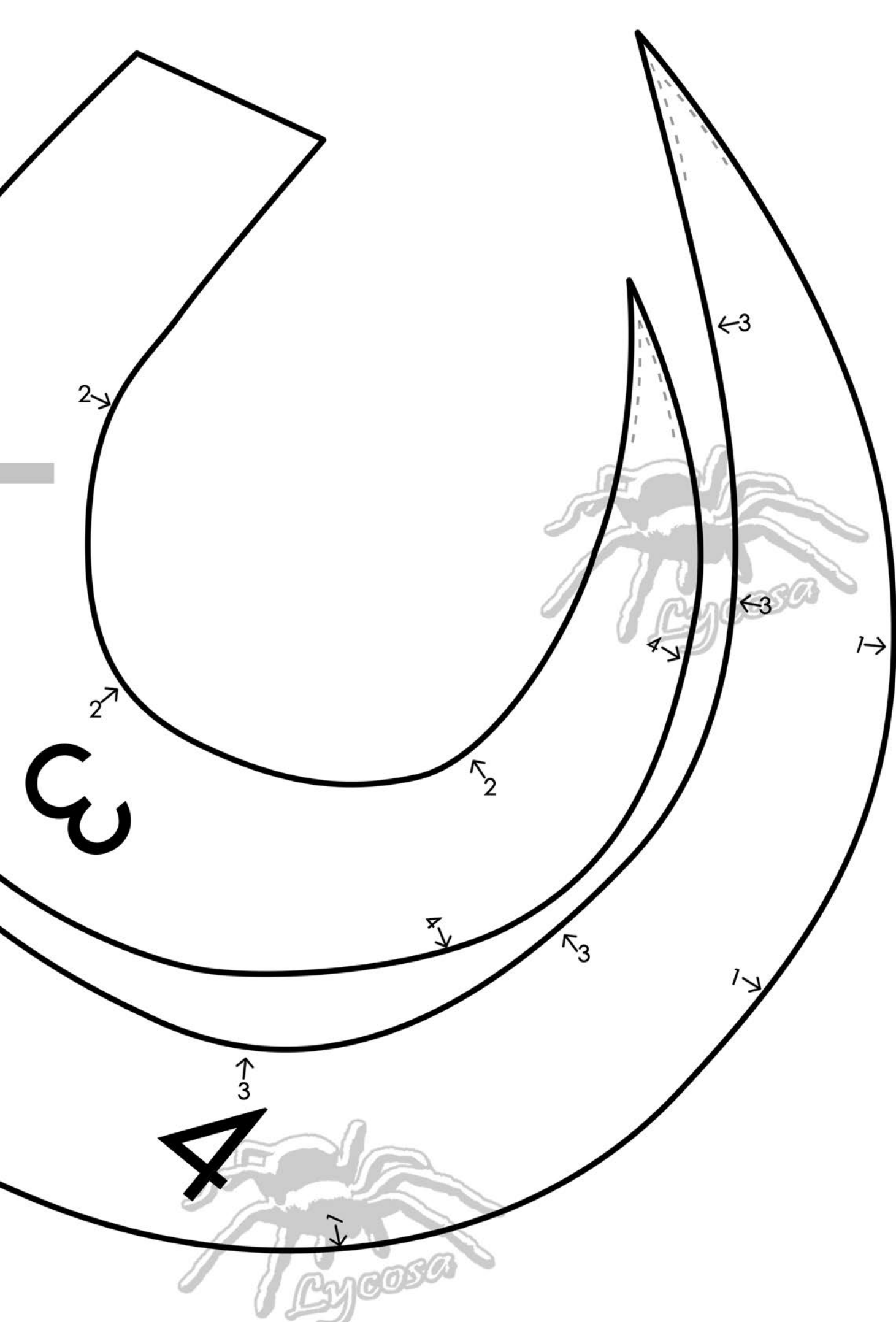

3

4